

RWL II Series

LED Roadway Lighting



Advantages of RWL II

- **Technologically Advanced**, low profile design
- Ultra bright industry leading **High Efficacy (lm/W)**
- **Proprietary Optical System** enabling wide angle glare-free lighting for most street lighting applications. Eliminating the need for costly and fragile plastic lenses
- Cost effective solution with a **Short ROI Period**
- Dark Sky Compliant / Full Cut-Off Optics
- L70 Rating @ Ta 25°C **Over 180,000 hour rated life**
- **Advanced Thermal Technology** enables low LED junction temperatures (Tj) for maintenance free long life
- **Dura-Guard** double layer epoxy coating with industry leading 10 year protection on weather and corrosion
- Optional programmable **RF Wireless Smart Control System with daylight sensor** enabling greater savings and flexibility
- A true industrial grade street light designed to withstand harsh outdoor weather conditions with **IP68** (water, dust & vapor-proof) rating and an exceptional **10-Year Limited Warranty**
- Designed and Engineered in the **USA**

Application

- Type II Street Lighting
- Type V Round
- Type V Square
- Parking Lots
- Perimeter Lighting
- Parks and Walkway Lighting

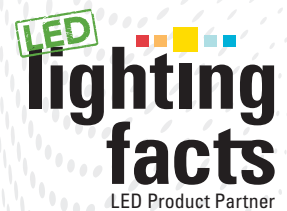

RWL II Series

LED Roadway Lighting

Optics Options

02 - Type II / asymmetric for street and pedestrian walkway applications

S - Short

M - Medium

L - Long

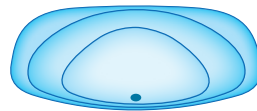
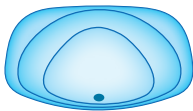

R5 - Type V Round / symmetric for street, parking lot and pedestrian walkway applications

S - Short

M - Medium

L - Long

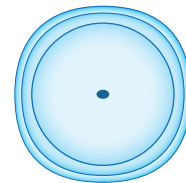
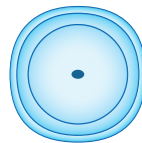

F5 - Type V Opaque - Frosted / symmetric for ultra uniform & low glare application

L - Long

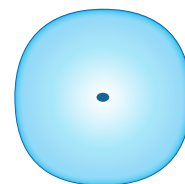

S5 - Type V Square / symmetric for street, parking lot and pedestrian walkway applications

S - Short

M - Medium

L - Long

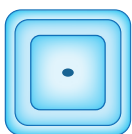

RWL II Series

LED Roadway Lighting

Ordering Information

RWLI	Wattage	Voltage	Optics	Pitch	CCT	Driver
	075 = 75Watt 100 = 100Watt 120 = 120Watt 150 = 150Watt 185 = 185Watt 220 = 220Watt	UV = 90-277VAC HV = 305-528VAC	02 = Type II R5 = Type V Round S5 = Type V Square F5 = Type V Frosted	S = Short M = Medium L = Long	30 = 3000K 40 = 4000K 50 = 5000K	ND = Non-Dimmable DM = Dimmable DS = Dimmable With Sensor DL = Dali Control LS = Dali Control With Sensor

NOTE: Outdoor application and corrosive environment please request glass lens.
Gray is the standard exterior color. Other colors are available on request.

Example

Part Number	Part Description
RWLI-100HV-02M-50DS	LED Road Way Light / 100 Watt / 305-528VAC / Type II / Medium Pitch / 5000K Cool White / Dimmable with Daylight Sensor

External Dimensions

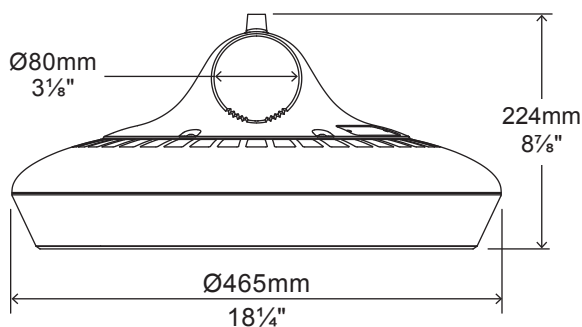

Packaging Information

Quantity	Dimensions (LxWxH)	Weight
1	50 x 50 x 31 cm 19 5/8 x 19 5/8 x 12 1/4 in	13 kg 28.6 lbs

RWL II Series

LED Roadway Lighting - 100Watt - Type II

Specification - Type II Short

Input Voltage	90-277VAC 47~63Hz (348 & 480VAC available)
Fixture Watts	100 Watt
Lumens (Total) *	12,000 Lumens
Efficacy *	120 Lumens / W
LED Model	Lumileds / Nichia / Cree
Number of LEDs & Driving Current	24@380mA
CRI	75
T _s - Solder Point Temp *	54°C
L70 Rating @ T _a 25°C	> 180K hours
Lighting Control	Dimmable (0-10V, PWM) / DALI / Daylight & Motion Sensor
Warranty	10-Year Limited
Operational Temperature (T _a)	-40°C ~ 55°C
Storage Temp. / Humidity	-40°C ~ 80°C / IP68 Waterproof Rated Fixture
Transient Surge Protection	20kV / 10kA (L - L, L-G)

* Test data @ 25°C

NOTE: All Values Have ±7% Tolerance

NOTE: Light intensities measured directly below fixture



Illumination Levels

Mounting Height	LUX	FC
4m / 13ft	392	36.5
5m / 16.5ft	267	24.5
6m / 20ft	171	16
7m / 23ft	131	12
8m / 26ft	96	9
9m / 29.5ft	68	6.5
10m / 33ft	48	4.5

RWL II Series

LED Roadway Lighting - 100Watt - Type II

Specification - Type II Medium

Input Voltage	90-277VAC 47~63Hz (348 & 480VAC available)
Fixture Watts	100 Watt
Lumens (Total) *	12,100 Lumens
Efficacy *	121 Lumens / W
LED Model	Lumileds / Nichia / Cree
Number of LEDs & Driving Current	24@380mA
CRI	75
T _s - Solder Point Temp *	54°C
L70 Rating @ T _a 25°C	> 180K hours
Lighting Control	Dimmable (0-10V, PWM) / DALI / Daylight & Motion Sensor
Warranty	10-Year Limited
Operational Temperature (T _a)	-40°C ~ 55°C
Storage Temp. / Humidity	-40°C ~ 80°C / IP68 Waterproof Rated Fixture
Transient Surge Protection	20kV / 10kA (L - L, L-G)

* Test data @ 25°C

NOTE: All Values Have ±7% Tolerance

NOTE: Light intensities measured directly below fixture



Light Distribution Curve

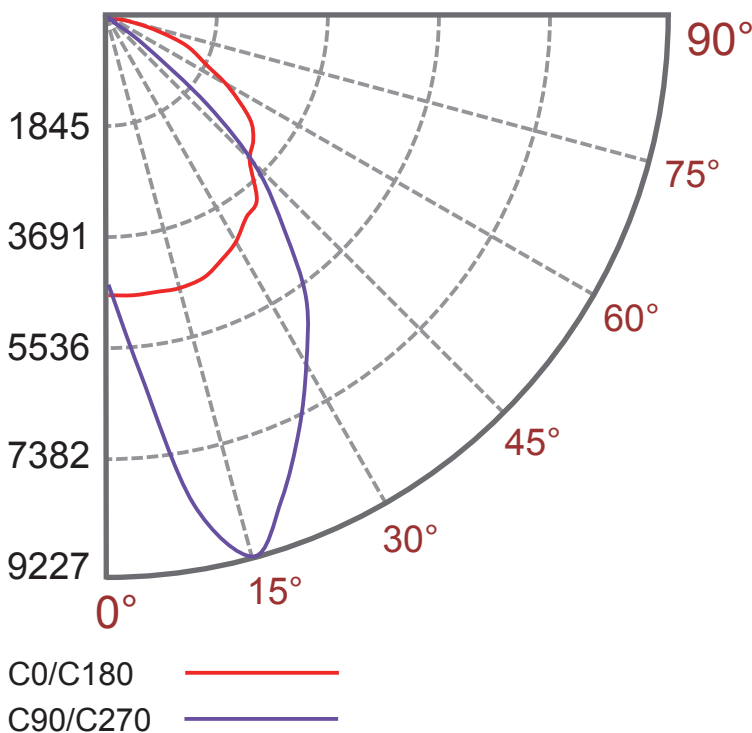

Zonal Lumen Summary

Zone (°)	Lumens	% Fixture
0-30	4101.9	33.9%
0-40	6485.6	53.6%
0-60	10357.6	85.6%
0-90	12100.0	100.0%
0-180	12100.0	100.0%

Illumination Levels

Mounting Height	LUX	FC
4m / 13ft	335	31
5m / 16.5ft	214.5	20
6m / 20ft	149	14
7m / 23ft	109	10
8m / 26ft	84	8
9m / 29.5ft	66	6
10m / 33ft	53.5	5

RWL II Series

LED Roadway Lighting - 100Watt - Type V Round

Specification - Type V Round Medium

Input Voltage	90-277VAC 47~63Hz (348 & 480VAC available)
Fixture Watts	100 Watt
Lumens (Total) *	13,600 Lumens
Efficacy *	136 Lumens / W
LED Model	Lumileds / Nichia / Cree
Number of LEDs & Driving Current	28@330mA
CRI	70 / 80
T _s - Solder Point Temp *	47°C
L70 Rating @ T _a 25°C	> 185K hours
Lighting Control	Dimmable (0-10V, PWM) / DALI / Daylight & Motion Sensor
Warranty	10-Year Limited
Operational Temperature (T _a)	-40°C ~ 55°C
Storage Temp. / Humidity	-40°C ~ 80°C / IP68 Waterproof Rated Fixture
Transient Surge Protection	20kV / 10kA (L - L, L-G)

* Test data @ 25°C

NOTE: All Values Have ±7% Tolerance

NOTE: Light intensities measured directly below fixture



Light Distribution Curve

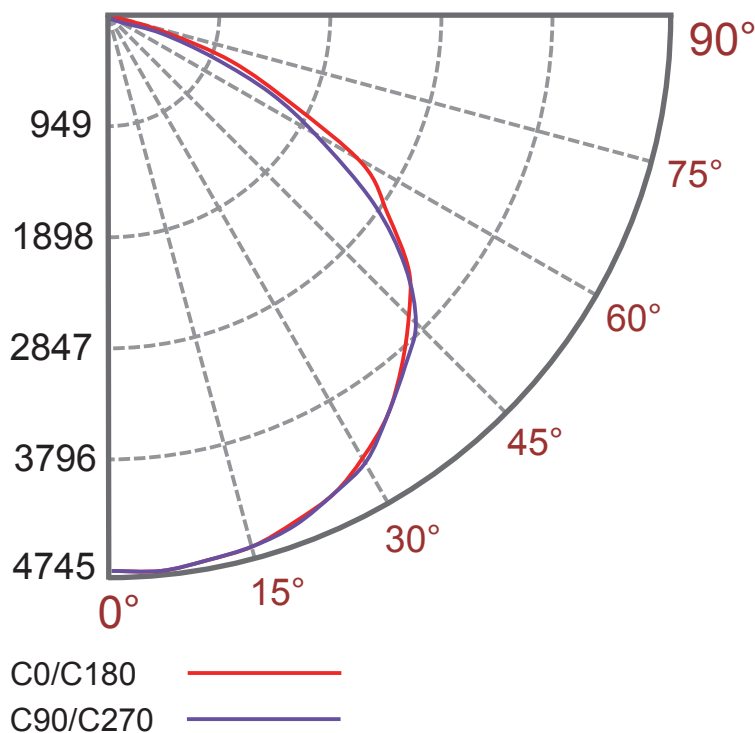

Zonal Lumen Summary

Zone (°)	Lumens	% Fixture
0-30	3838.0	27.4%
0-40	6446.6	46.1%
0-60	10487.1	85.6%
0-90	12100.0	100.0%
0-180	12100.0	100.0%

Illumination Levels

Mounting Height	LUX	FC
4m / 13ft	295	27.5
5m / 16.5ft	189	17.5
6m / 20ft	131	12
7m / 23ft	96	9
8m / 26ft	74	7
9m / 29.5ft	58	5.5
10m / 33ft	47	4.5

RWL II Series

LED Roadway Lighting - 100Watt - Type V Round

Specification - Type V Round Long

Input Voltage	90-277VAC 47~63Hz (348 & 480VAC available)
Fixture Watts	100 Watt
Lumens (Total) *	11,700 Lumens
Efficacy *	117 Lumens / W
LED Model	Lumileds / Nichia / Cree
Number of LEDs & Driving Current	28@330mA
CRI	70 / 80
T _s - Solder Point Temp *	47°C
L70 Rating @ T _a 25°C	> 185K hours
Lighting Control	Dimmable (0-10V, PWM) / DALI / Daylight & Motion Sensor
Warranty	10-Year Limited
Operational Temperature (T _a)	-40°C ~ 55°C
Storage Temp. / Humidity	-40°C ~ 80°C / IP68 Waterproof Rated Fixture
Transient Surge Protection	20kV / 10kA (L - L, L-G)

* Test data @ 25°C

NOTE: All Values Have ±7% Tolerance

NOTE: Light intensities measured directly below fixture



Light Distribution Curve

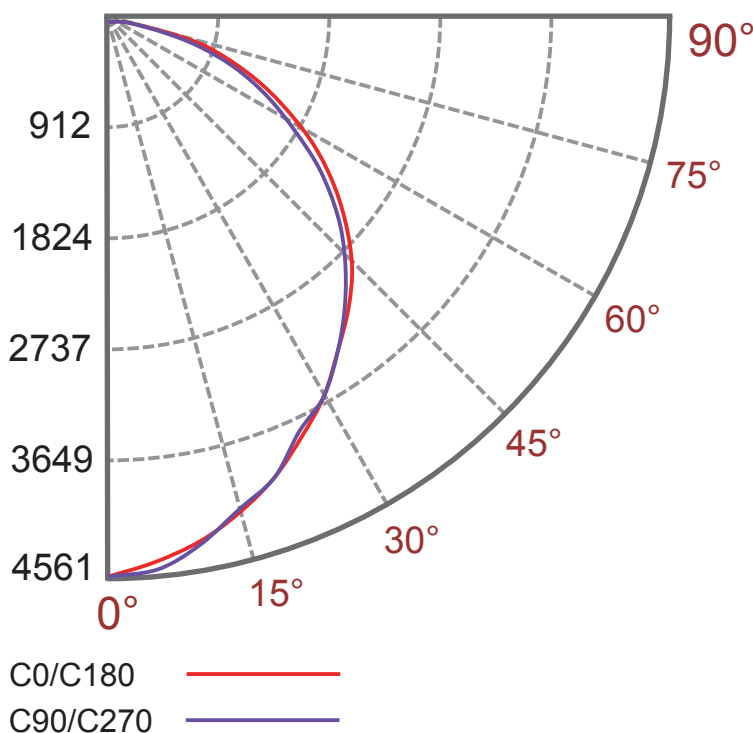

Zonal Lumen Summary

Zone (°)	Lumens	% Fixture
0-30	3205.8	27.4%
0-40	5393.7	46.1%
0-60	10015.2	85.6%
0-90	11700.0	100.0%
0-180	11700.0	100.0%

Illumination Levels

Mounting Height	LUX	FC
4m / 13ft	285	26
5m / 16.5ft	182	17
6m / 20ft	127	12
7m / 23ft	93	8.5
8m / 26ft	71	6.5
9m / 29.5ft	56	5
10m / 33ft	46	4

RWL II Series

LED Roadway Lighting - 100Watt - Type V Frosted

Specification - Type V Frosted Long

Input Voltage	90-277VAC 47~63Hz (348 & 480VAC available)
Fixture Watts	100 Watt
Lumens (Total) *	11,900 Lumens
Efficacy *	119 Lumens / W
LED Model	Lumileds / Nichia / Cree
Number of LEDs & Driving Current	28@330mA
CRI	70 / 80
T _s - Solder Point Temp *	47°C
L70 Rating @ T _a 25°C	> 185K hours
Lighting Control	Dimmable (0-10V, PWM) / DALI / Daylight & Motion Sensor
Warranty	10-Year Limited
Operational Temperature (T _a)	-40°C ~ 55°C
Storage Temp. / Humidity	-40°C ~ 80°C / IP68 Waterproof Rated Fixture
Transient Surge Protection	20kV / 10kA (L - L, L-G)

* Test data @ 25°C

NOTE: All Values Have ±7% Tolerance

NOTE: Light intensities measured directly below fixture



Light Distribution Curve

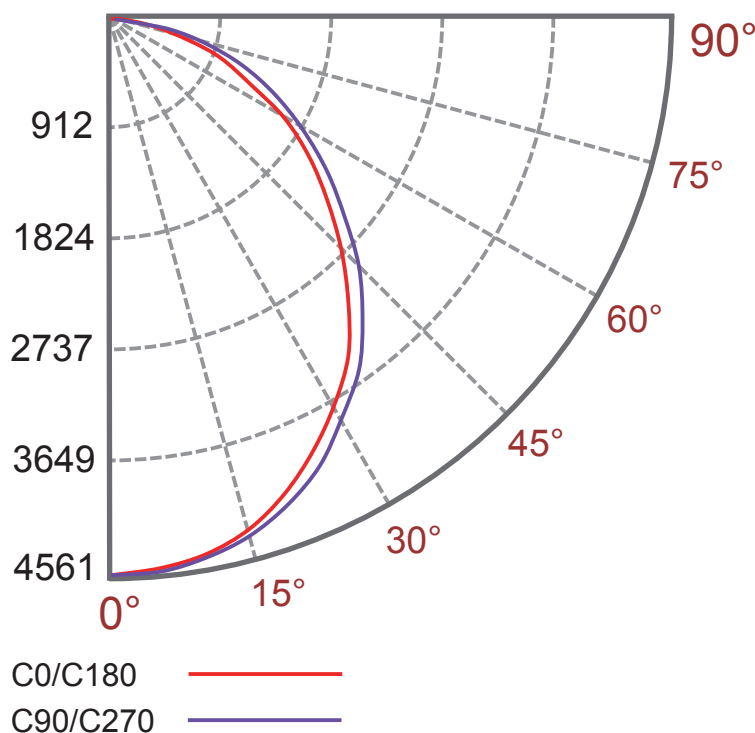

Zonal Lumen Summary

Zone (°)	Lumens	% Fixture
0-30	3498.6	29.4%
0-40	5640.6	47.4%
0-60	9615.2	80.8%
0-90	11864.3	99.7%
0-180	11900.0	100.0%

Illumination Levels

Mounting Height	LUX	FC
4m / 13ft	297	27.5
5m / 16.5ft	190	17.5
6m / 20ft	132	12
7m / 23ft	97	9
8m / 26ft	74	7
9m / 29.5ft	59	5.5
10m / 33ft	47	4

RWL II Series

LED Roadway Lighting - 100Watt - Type V Square

Specification - Type V Square Short

Input Voltage	90-277VAC 47~63Hz (348 & 480VAC available)
Fixture Watts	100 Watt
Lumens (Total) *	13,600 Lumens
Efficacy *	136 Lumens / W
LED Model	Lumileds / Nichia / Cree
Number of LEDs & Driving Current	28@330mA
CRI	75
T _s - Solder Point Temp *	47°C
L70 Rating @ T _a 25°C	> 180K hours
Lighting Control	Dimmable (0-10V, PWM) / DALI / Daylight & Motion Sensor
Warranty	10-Year Limited
Operational Temperature (T _a)	-40°C ~ 55°C
Storage Temp. / Humidity	-40°C ~ 80°C / IP68 Waterproof Rated Fixture
Transient Surge Protection	20kV / 10kA (L - L, L-G)

* Test data @ 25°C

NOTE: All Values Have ±7% Tolerance

NOTE: Light intensities measured directly below fixture



Light Distribution Curve

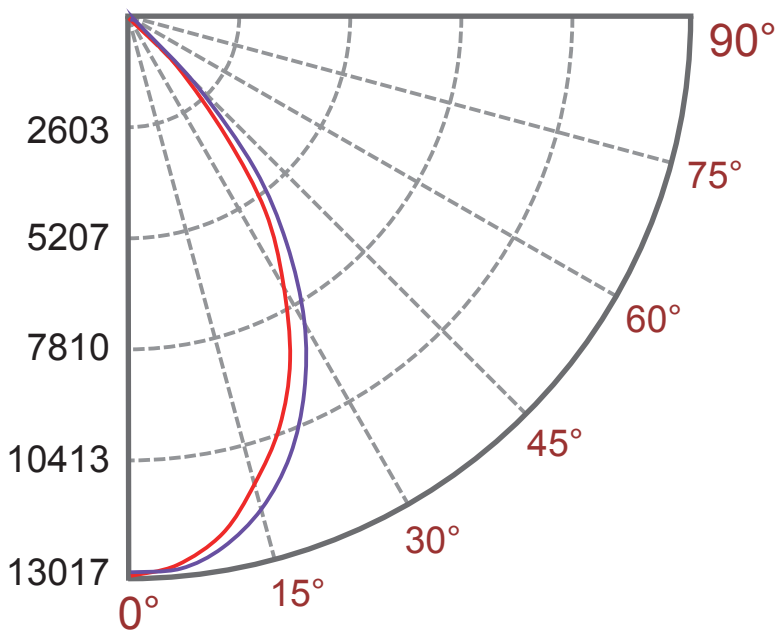

C0/C180 —
 C90/C270 —

Zonal Lumen Summary

Zone (°)	Lumens	% Fixture
0-30	8132.8	59.8%
0-40	11628.0	85.5%
0-60	13586.4	99.9%
0-90	13600.0	100.0%
0-180	13600.0	100.0%

Illumination Levels

Mounting Height	LUX	FC
4m / 13ft	813.5	75.5
5m / 16.5ft	521	48.5
6m / 20ft	361.5	33.5
7m / 23ft	266	25
8m / 26ft	203	19
9m / 29.5ft	161	15
10m / 33ft	130	12